

Parts Catalog



WORLDLAWN®

WYZ42XP/46XP/50XP/60XP

Residential Zero Turn Mower



WorldlawnPower Equipment, Inc.
401 N. Commerce Street, Beatrice, NE 68310
Toll Free Number: 1-800-267-4255



Table of Contents

Table of Contents

Mower Deck Assembly.....	1
Front Frame Assembly.....	3
Control Assembly.....	5
Engine System	7
Driving System.....	9
Mower Deck Height Adjustment	10
Fuel Tank Assembly.....	11
Safety/Operation and Product Decals.....	12
Electrical System	14



WORLDLAWN®

Mower Deck Assembly

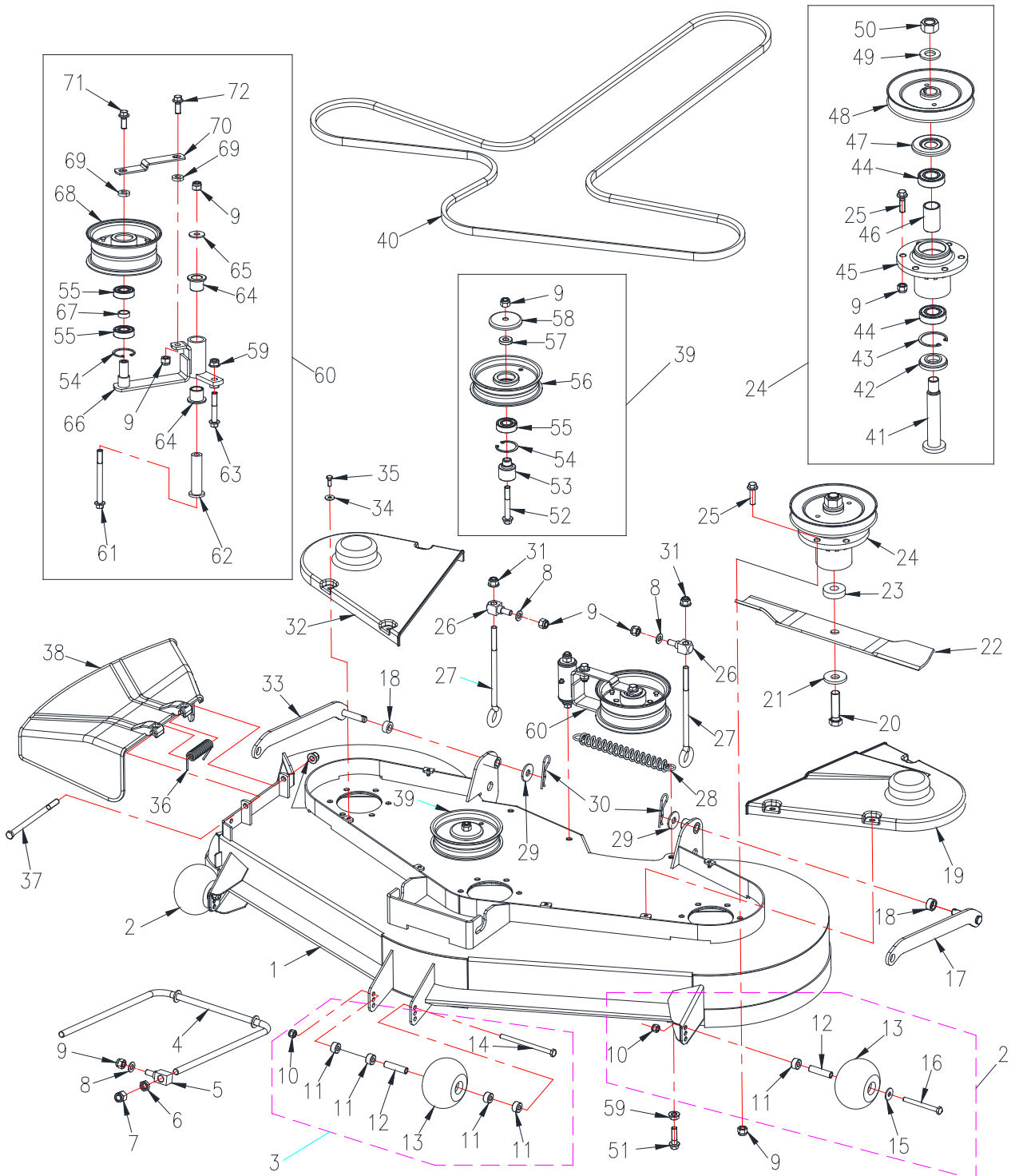



WORLDLAWN®

Mower Deck Assembly

Ref	P/N	Description	42XP	46XP	50XP	60XP	Ref	P/N	Description	42XP	46XP	50XP	60XP
1	4211040	Deck Weldment	x				33	5001604	Right Hanging Plate	x	x	x	x
	4601340	Deck Weldment		x			34	B96-6	Flat washer M6	x	x	x	x
	5001340	Deck Weldment			x		35	B5783-616	Hex hd bolt M6x16	x	x	x	x
	6011040	Deck Weldment				x	36	5001007	Torsion Spring	x	x	x	x
2	5001335	Anti Scalp Roller ASM	x	x	x	x	37	2802008	Bolt M10*160	x	x	x	x
3	5001330A	Anti Scalp Roller ASM	x	x	x	x	38	4211090	Discharge Chute	x			
4	5001304	Front Deck Support Rod	x	x	x	x		5001004	Discharge Chute		x	x	x
5	5001607	Support Rod Pivot Bushing	x	x	x	x	39	5201010	Tension Pulley ASM	x	x	x	x
6	B6172-12	Locknut M12	x	x	x	x	40	4211002	Blade Drive Belt	x			
7	B6182-12	Locknut M12	x	x	x	x		4601002	Blade Drive Belt		x		
8	B97.1-10	Flat Washer M10	x	x	x	x		5001002	Blade Drive Belt			x	
9	B6182-10	Locknut M10	x	x	x	x		6011001	Blade Drive Belt				x
10	B6182-8	Locknut M8	x	x	x	x	41	4211101	Spindle Shaft	x			
11	5001332A	Bushing 2	x	x	x	x		6011143	Spindle Shaft		x	x	x
12	5001334	Bolt Sleeve	x	x	x	x	42	5201043	Lower Dust Guard	x	x	x	x
13	5001333	Floating Roller	x	x	x	x	43	B893.2-52	Snap Ring M52	x	x	x	x
14	B5782-8120	Bolt M8x120	x	x	x	x	44	B276-6205RS	Bearing 6205-2RS	x	x	x	x
15	B96-8	Flat washer M8	x	x	x	x	45	5201050	Spindle Housing	x	x	x	x
16	B5782-880	Bolt M8x80	x	x	x	x	46	5201049	Spindle Bearing Spacer	x	x	x	x
17	5001601	Left Hanging Plate	x	x	x	x	47	5201044	Upper Dust Guard	x	x	x	x
18	5001603	Bearing Spacer	x	x	x	x	48	4211105	Blade Pulley	x			
19	4211110	Belt Cover	x					4601356	Blade Pulley		x		
	4601120	Left Belt Cover		x				5001306	Blade Pulley			x	
	5001017	Left Belt Cover			x			6011141	Blade Pulley				x
	6011002	Left Belt Cover				x	49	5201048	Washer (2)	x	x	x	x
20	B5785-161560	Bolt M16x1.5x60	x	x	x	x	50	B6173-20	Nut M20x1.5	x			
21	5201042	Washer (1)	x	x	x			B6171-20	Nut M20x1.5		x	x	x
22	4211001U	Blade	x				51	B5787-1035	Bolt M10x35			x	
	4601001U	Blade		x			52	B5787-1070	Bolt M10x70	x	x	x	x
	5001001U	Blade			x		53	5201011	Idler Spacer Bushing	x	x	x	x
	6001004U	Blade				x	54	B893.1-40	Snap Ring M40	x	x	x	x
23	5001307	Blade Washer	x	x	x	x	55	B276-6203RS	Bearing 6203-2RS	x	x	x	x
24	4211100	Spindle Assembly	x				56	5201012	Idler Pulley	x	x	x	x
	4601355	Spindle Assembly		x			57	5002164	Padding Block	x	x	x	x
	5001305	Spindle Assembly			x		58	5201291	Bearing Cover	x	x	x	x
	6011140	Spindle Assembly				x	59	B6177-10	Locknut M10	x	x	x	x
25	B5787-1035	Bolt M10x35	x	x	x	x	60	5001080	Tension Pulley ASM	x	x	x	x
26	5001607	Support Rod Pivot Bushing	x	x	x	x	61	B5787-10110	Bolt M10x110	x	x	x	x
27	5001008	Deck lift Rod	x	x			62	5001081	Pivot Tensioner Mount	x	x	x	x
	5001401	Deck lift Rod			x	x	63	B5787-1060	Bolt M10x60	x	x	x	x
28	5004107	Tension Spring	x				64	3301003	Olite bronze bushing	x	x	x	x
	4211004	Tension Spring		x	x	x	65	5001083	Washer M10	x	x	x	x
	5207015	Tension Spring					66	5001090	Deck Belt Tension Arm	x	x	x	x
29	5001006	Washer M12	x	x	x	x	67	5201077	Bearing Spacer	x	x	x	x
30	4806002	Hair Pin	x	x	x	x	68	5201064	Tension Pulley	x	x	x	x
31	B6183-10	Locknut M10	x	x	x	x	69	5201078	Bearing Spacer M10	x	x	x	x
32	4211110	Belt Cover	x				70	5201062	Tension Pulley Brace	x	x	x	x
	4601119	Right Belt Cover		x			71	B5787-1025	Bolt M10X25	x	x	x	x
	5001016	Right Belt Cover			x		72	B5787-1030	Bolt M10X30	x	x	x	x
	6011003	Right Belt Cover				x							



Front Frame Assembly

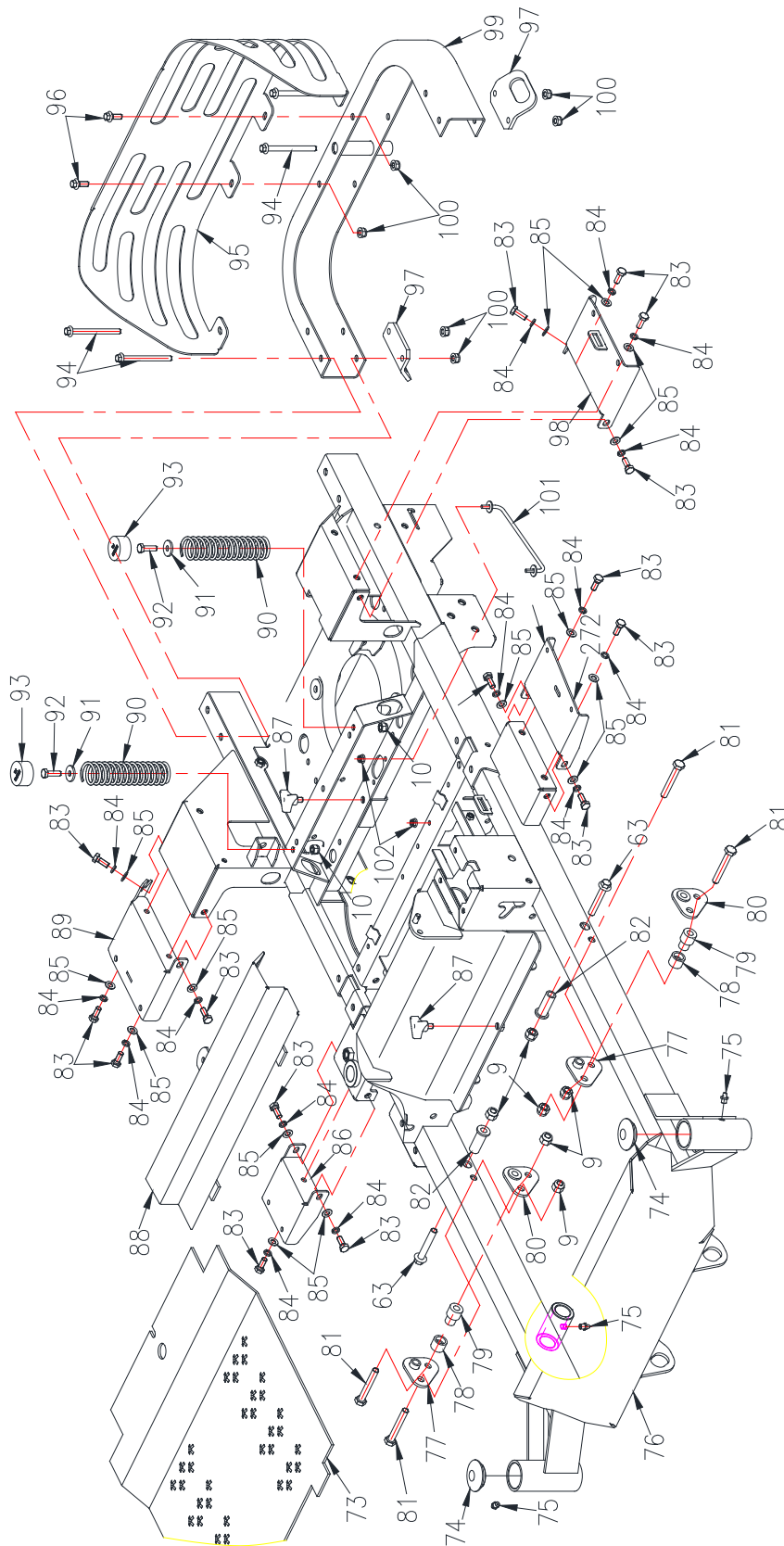



WORLDLAWN®

Front Frame Assembly

Ref	P/N	Description	42XP	46XP	50XP	60XP	Ref	P/N	Description	42XP	46XP	50XP	60XP
9	B6182-10	Locknut M10	x	x	x	x	87	3302190	Three-Arm Knob	x	x	x	x
10	B6182-8	Locknut M8	x	x	x	x	88	5002385A	Fan Cover	x	x	x	x
63	B5787-1060	Bolt M10×60	x	x			89	5002681	Rear Support Plate RH	x	x	x	x
73	5002643	Foot Plate	x	x	x	x	90	5002022	Spring	x	x	x	x
74	5002020	Cap,Dust	x	x	x	x	91	2802183B	Washer	x	x	x	x
75	B1152-8	Grease Fitting M8×1	x	x	x	x	92	B5783-825	Bolt M8×25	x	x	x	x
76	5002601	Frame	x	x	x	x	93	5203045	Spring Cover	x	x	x	x
77	5000610	Front Hanging Plate			x	x	94	B5787-890	Bolt M8×90	x	x	x	x
78	5000614	Spacer			x	x	95	5002659	Rear Engine Guard	x	x	x	x
79	5000613	Spacer			x	x	96	B5787-820	Bolt M8×20	x	x	x	x
80	5000615	Front Hanging Plate			x	x	97	5009026	Fixed Plate	x	x	x	x
81	B5782-1065	Bolt M10×65			x	x	98	5002678	Rear Support Plate RH	x	x	x	x
82	5000607	Spacer	x	x			99	5002707	Rear Guard	x	x	x	x
83	B5783-820	Bolt M8×20	x	x	x	x	100	B6183-8	Locknut M8	x	x	x	x
84	B93-8	Lock Washer M8	x	x	x	x	101	5002390A	Wire rod welding	x	x	x	x
85	B97.1-8	Flat Washer M8	x	x	x	x	102	B6183.1-6	Locknut M6	x	x	x	x
86	5002688	Front Support Plate RH	x	x	x	x	272	5002686	Front Support Plate LH	x	x	x	x



WORLDLAWN®

Control Assembly

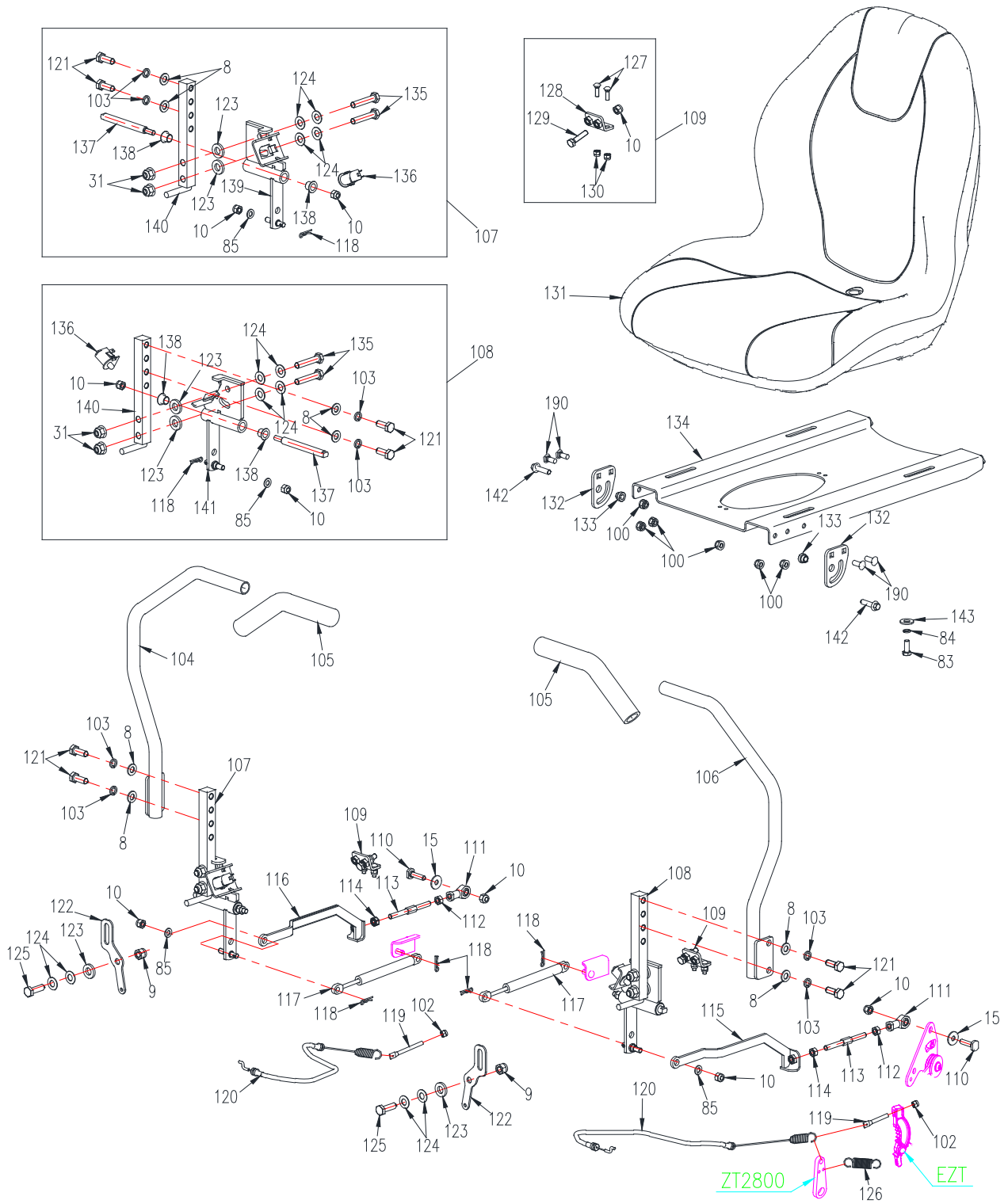



WORLDLAWN®

Control Assembly

Ref	P/N	Description	42XP	46XP	50XP	60XP	Ref	P/N	Description	42XP	46XP	50XP	60XP
8	B97.1-10	Flat Washer M10	x	x	x	x	121	B5783-1025	Bolt M10×25	x	x	x	x
9	B6182-10	Locknut M10	x	x	x	x	122	5002661	Hanging Board	x	x	x	x
10	B6182-8	Locknut M8	x	x	x	x	123	543152	Washer M10	x	x	x	x
83	B5783-820	Bolt M8×20	x	x	x	x	124	B1972- A22.5-2	Washer	x	x	x	x
84	B93-8	Lock Washer M8	x	x	x	x	125	B5783-1030	Bolt M10×30	x	x	x	x
85	B97.1-8	Flat Washer M8	x	x	x	x	126	5002260	Brake Tension Spring	x	x	x	x
100	B6183-8	Locknut M8	x	x	x	x	127	B801-616	Bolt M6×16	x	x	x	x
102	B6183-6	Locknut M6	x	x	x	x	128	5002250A	Limited Adjustable Plate	x	x	x	x
103	B93-10	Lock Washer M10	x	x	x	x	129	B5783-840	Bolt M8×40	x	x	x	x
104	5002672	Right Handle	x	x	x	x	130	B6182-6	Locknut M6	x	x	x	x
105	5002034	Handle Grip	x	x	x	x	131	5000603	YY70 Seat	x	x	x	x
106	5002674	Left Handle	x	x	x	x	132	5000623	Limited Plate	x	x	x	x
107	5002666	RH Handle Mount ASM	x	x	x	x	133	5000619	Idler Spacer Bushing	x	x	x	x
108	5002663	LH Handle Mount ASM	x	x	x	x	134	5000618	Seat Plate	x	x	x	x
109	5002623	Limited Adjustable Plate ASM	x	x	x	x	135	B5782-1050	Bolt M10×50	x	x	x	x
110	5002009	Axle Pin 2	x	x	x	x	136	353048	Plunger Switch	x	x	x	x
111	SIBJK8T-L	Rod End Bearing	x	x	x	x	137	5002111	Pivot Shaft	x	x	x	x
112	B6170-8-L	Locknut M8-L	x	x	x	x	138	543154	Idler Spacer Bushing	x	x	x	x
113	5002726	Screw M8	x	x	x	x	139	5002715	Right Pivot Block Weldment	x	x	x	x
114	B6170-8	Locknut M8	x	x	x	x	140	5002664	Pole	x	x	x	x
115	5002725	Left Control link	x	x	x	x	141	5002716	Left Pivot Block Weldment	x	x	x	x
116	5002722	Right Control link	x	x	x	x	142	B5787-830	Bolt M8×30	x	x	x	x
117	5205012B	Damper	x	x	x	x	190	B801-820	Bolt M8×20	x	x	x	x
118	XSZ56-1-17	Hair Pin	x	x	x	x							
119	5002026A	Brake Adjustment Link	x	x									
120	5002210A	Brake Cable	x	x	x	x							



Ref	P/N	Description	42XP	46XP	50XP	60XP	Ref	P/N	Description	42XP	46XP	50XP	60XP
9	B6182-10	Locknut M10	x	x	x	x	165	B93-10	Lock Washer M10	x	x	x	x
10	B6182-8	Locknut M8	x	x	x	x		B1972-A20-1	Washer (Loncin)	x	x	x	x
84	B93-8	Lock Washer M8	x	x	x	x	166	B5782-10100	Bolt M10×100	x	x	x	x
85	B97.1-8	Flat Washer M8	x	x	x	x	167	3307004	Washer M11	x	x	x	x
143	3203004	Battery Strap	x	x	x	x	168	5002163	Pivot Bushing	x	x	x	x
144		Battery	x	x	x	x	169	B2685-202420	Bearing 20×24×20	x	x	x	x
145	B62-6	Nut M6	x	x	x	x	170	B893.2-47	Snap Ring M47	x	x	x	x
146	5208203	hook rod	x	x	x	x	171	B276-6303RS	Bearing 6303-2RS	x	x	x	x
147	6012004	Pump Drive Belt	x	x	x	x	172	5002175	Tension Idler	x	x	x	x
148	4806004	Idler Spring	x	x	x	x	173	5002164	Padding block	x	x	x	x
149	463564	Clutch	x	x			174	6012011	Idler Fixed seat	x	x	x	x
	4804005A	Clutch			x	x	175	4808002	Washer	x	x	x	x
150	5201061	Washer	x	x	x	x	176	5002161	Spacer	x	x	x	x
151	5203412	Bolt 7/16-20UNF×3	x	x	x	x	177	6012015	Tension Idler	x	x	x	x
152	B5783-835	Bolt M8×35	x	x	x	x	178	3302058	Washer 10	x	x	x	x
154	B5782-890	Bolt M8×90	x	x	x	x	179	B5782-1050	Bolt M10×50	x	x	x	x
155	5203408	Washer	x	x	x	x	180	B5783-820	Bolt M8×20	x	x	x	x
156	5203410	Rubber Washer M17	x	x	x	x		B6170-8	Nut M8	x	x	x	x
157	5203411	Clutch Stop Strap	x	x	x	x	181	5002268	Muffler(Kawasaki FR)	x	x	x	x
158	5203409	Bushing	x	x	x	x		P5908	Muffler(Loncin)	x	x	x	x
159	5002371	Clutch Stop Spacer	x	x	x	x		5002269	Muffler(B&S)	x	x	x	x
160	3607002	Bushing	x	x	x	x	182		Kawasaki FR651V	x	x		
161	5002152	Pump Drive Pulley	x	x	x	x			Kawasaki FR691V			x	x
162	5203405	Key 6.35×25	x	x	x	x			LC2P77F/708CC-A	x	x	x	
163	6012010A	Tension Pulley Assembly	x	x	x	x			LC2P82F/803CC-A				x
164	B5783-835	Hex Hd Bolt M8×35	x	x	x	x			B&S 20HP	x	x		
	5203435	Bolt 3/8-16UNC×1-1/2	x	x	x	x			B&S 26HP		x	x	x
	5002494	Bolt 3/8-16×1-1/8 HWH THD FRMG	x	x	x	x							



WORLDLAWN®

Driving System

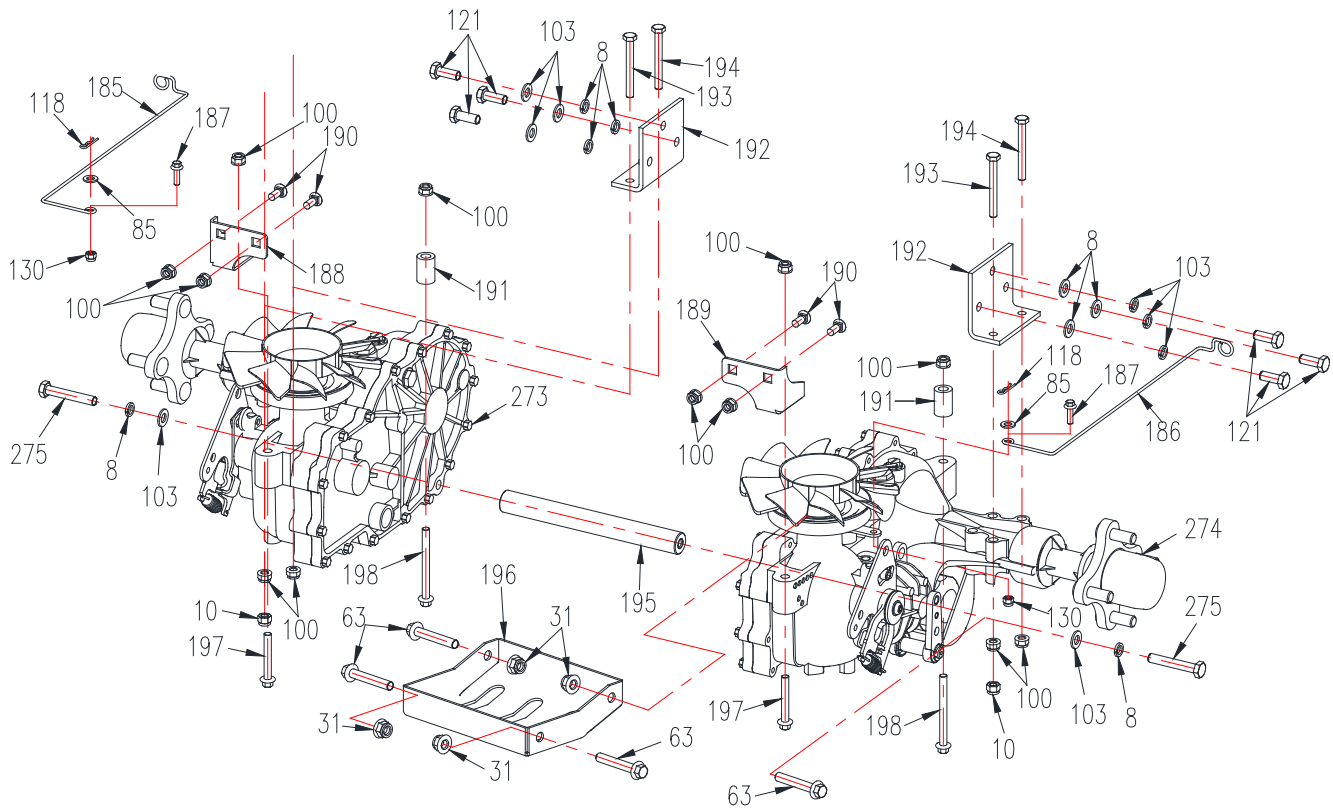

Ref	P/N	Description	42XP	46XP	50XP	60XP	Ref	P/N	Description	42XP	46XP	50XP	60XP
8	B97.1-10	Flat Washer M10	x	x	x	x	190	B801-820	Bolt M8×20	x	x	x	x
10	B6182-8	Locknut M8	x	x	x	x	191	5002673	Idler Spacer Bushing	x	x	x	x
31	B6183-10	Locknut M10	x	x	x	x	192	5002013	Outer Axle Bracket	x	x	x	x
63	B5787-1060	Bolt M10×60	x	x			193	B5782-870	Bolt M8×70	x	x		
85	B97.1-8	Flat Washer M8	x	x	x	x		B5782-880	Bolt M8×80			x	x
100	B6183-8	Locknut M8	x	x	x	x	194	B5782-870	Bolt M8×70	x	x	x	x
103	B93-10	Lock Washer M10	x	x	x	x	195	6012020	Axle			x	x
118	XSZ56-1-17	Hair Pin	x	x			196	5002657	Connecting Seat	x	x		
130	B6182-6	Locknut M6			x	x	197	B5787-855	Bolt M8×55	x	x	x	x
185	5002024	Release, Hydro RH	x	x			198	B5787-885	Bolt M8×85	x	x	x	x
	6012009	Release, Hydro RH			x	x	273	5002011A	Right Drive Axle	x	x		
186	5002023	Release, Hydro LH	x	x				6012014A	Right Drive Axle			x	x
	6012008	Release, Hydro LH			x	x	274	5002010A	Left Drive Axle	x	x		
187	B5787-620	Bolt M6×20			x	x		6012013A	Left Drive Axle			x	x
188	5002655	Fixed Plate, Front RH	x	x	x	x	275	B5782-1060	Bolt M10×60			x	x
189	5002656	Fixed Plate, Front LH	x	x	x	x							

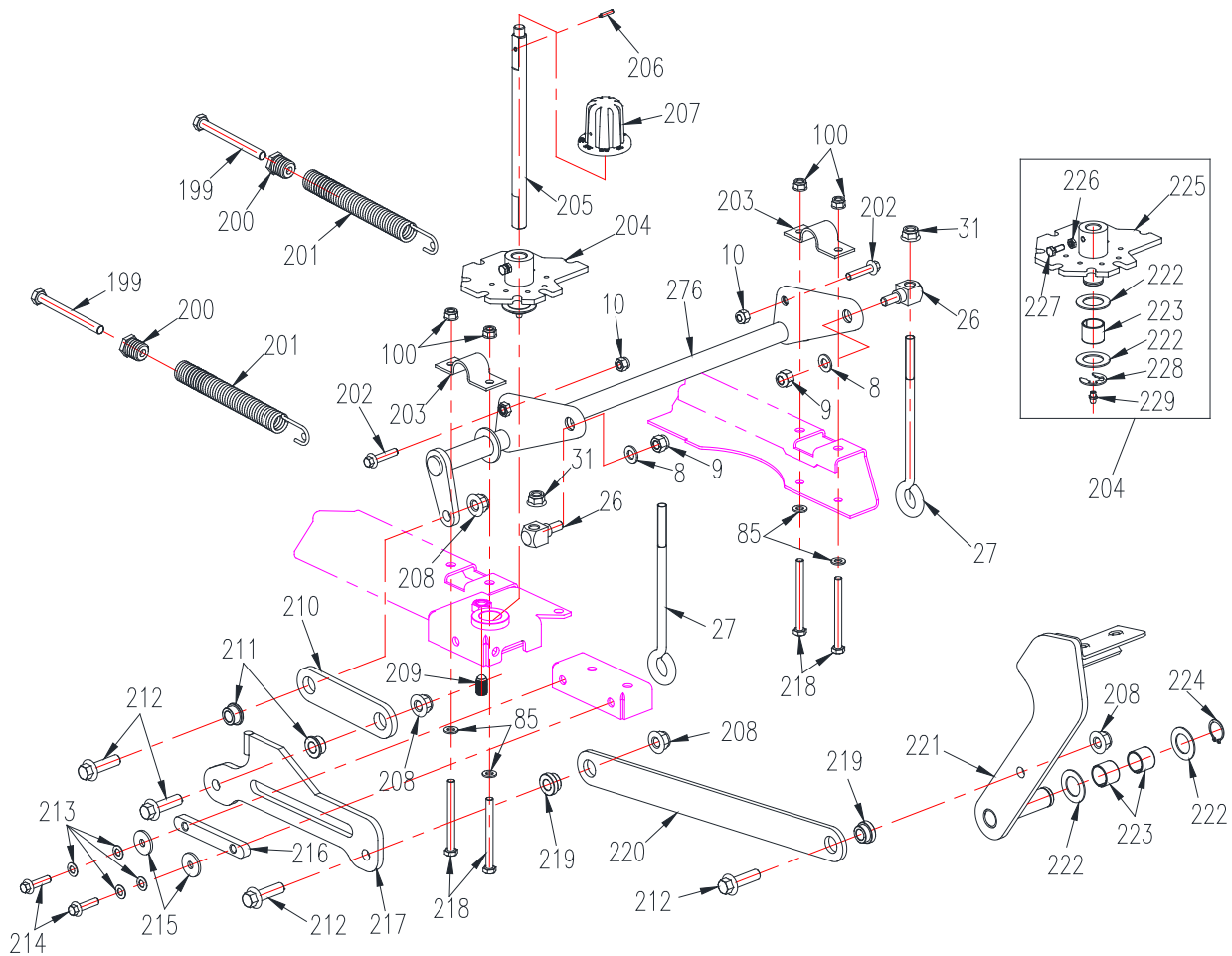

Ref	P/N	Description	42XP	46XP	50XP	60XP	Ref	P/N	Description	42XP	46XP	50XP	60XP
8	B97.1-10	Flat Washer M10	x	x	x	x	212	B5787-1240	Bolt M12×40	x	x	x	x
9	B6182-10	Locknut M10	x	x	x	x	213	B1972-A16	Washer	x	x	x	x
10	B6182-8	Locknut M8	x	x	x	x	214	B5787-830	Bolt M8×30	x	x	x	x
26	5001607	Support Rod Pivot Bushing	x	x	x	x	215	5203408	Washer	x	x	x	x
31	B6183-10	Locknut M10	x	x	x	x	216	5002634	Heel Block	x	x	x	x
85	B97.1-8	Flat Washer M8	x	x	x	x	217	5002640	Limit Plate	x	x	x	x
100	B6183-8	Locknut M8	x	x	x	x	218	B5782-885	Bolt M8×85	x	x	x	x
199	B5783-10110	Bolt M10×110	x	x	x	x	219	5002541A	Axle Sleeve	x	x	x	x
200	5002677	Tension Spring Joint	x	x	x	x	220	5002639	Connecting Plate	x	x	x	x
201	5002676	Tension Spring	x	x	x	x	221	5002646	Foot Swing Arm	x	x	x	x
202	B5787-835	Bolt M8×35	x	x	x	x	222	5202020	Washer	x	x	x	x
203	5002306A	Clamp	x	x	x	x	223	B12613-252220	Bearing 25×22×20	x	x	x	x
204	5002702	Knob ASM	x	x	x	x	224	B894.1-22	Snap Ring M22	x	x	x	x
205	5000622	Rotation Shaft	x	x	x	x	225	5002630	Cutting Height Bracket	x	x	x	x
206	B75-420	Bolt M4×20	x	x	x	x	226	B6172.1-6	Nut M8	x	x	x	x
207	5000621	Knob	x	x	x	x	227	B5783-616	Bolt M6×16	x	x	x	x
208	B6183-12	Locknut M12	x	x	x	x	228	B896-15	Circlip	x	x	x	x
209	YJT1113-1220	Glass Bead Screw M12×20	x	x	x	x	229	B1152-6	Grease Fitting M6	x	x	x	x
210	5002638	Connecting Plate	x	x	x	x	276	5002635	Deck Lift Shaft Weldment	x	x	x	x
211	5002519A	Axle Sleeve	x	x	x	x							



Fuel Tank Assembly

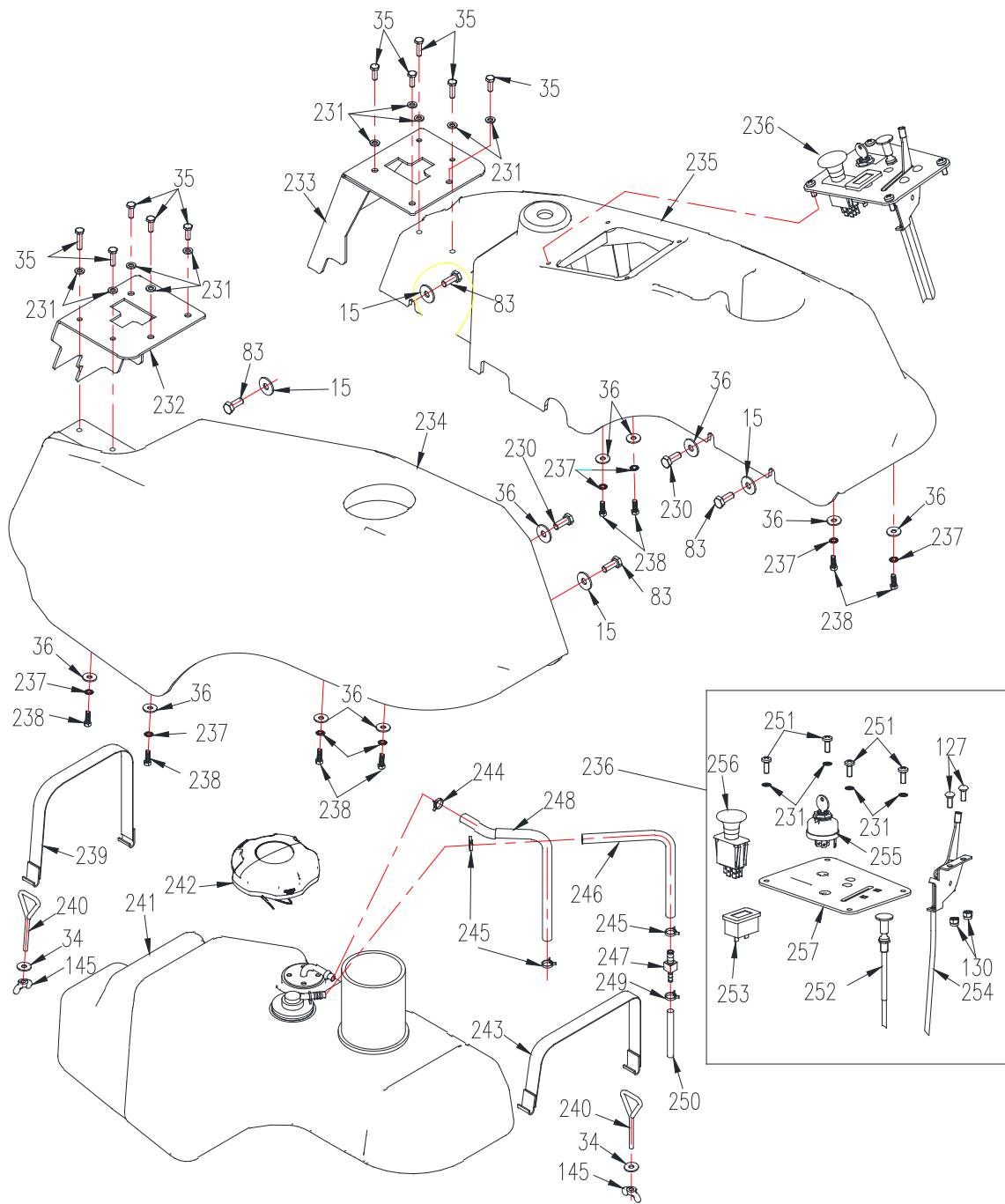



WORLDLAWN®

Fuel Tank Assembly







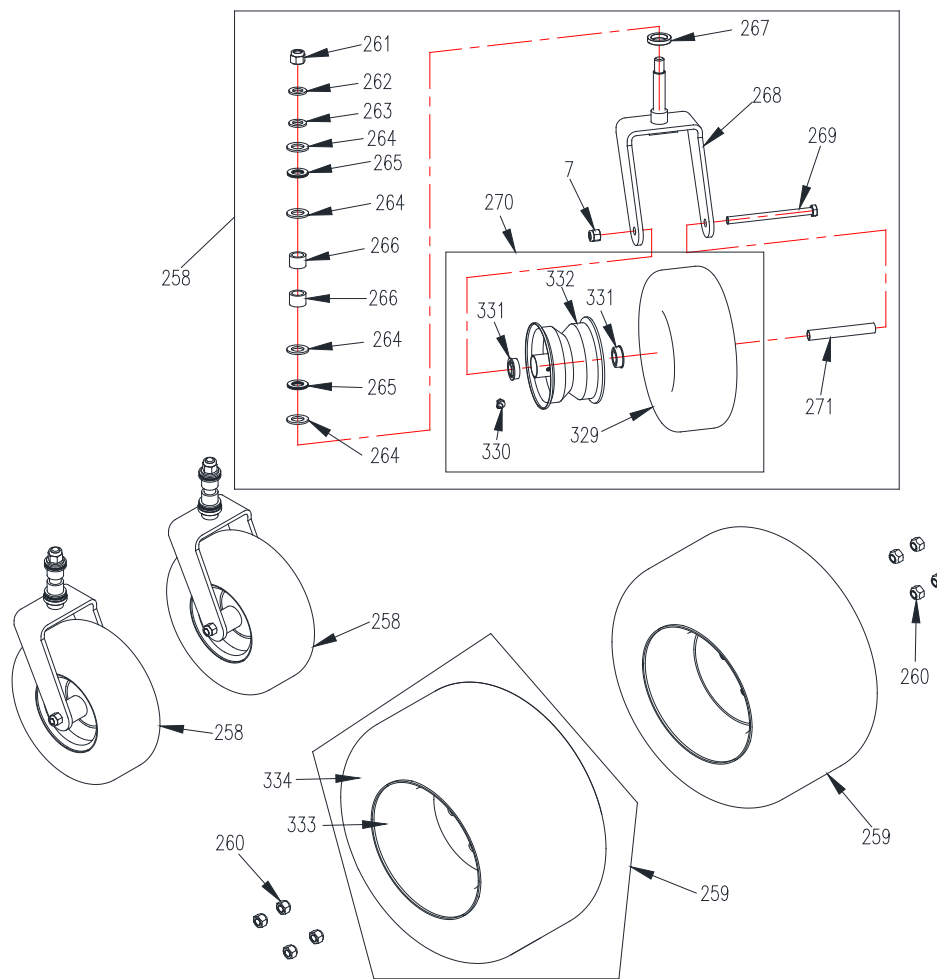





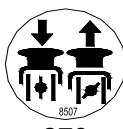

Ref	P/N	Description	42XP	46XP	50XP	60XP	Ref	P/N	Description	42XP	46XP	50XP	60XP
15	B96-8	Flat washer M8	x	x	x	x	242	363413	Fuel Tank Cap	x	x	x	x
34	B96-6	Flat washer M6	x	x	x	x	243	5000667	Fuel Tank Pressing Strap	x	x	x	x
35	B5783-616	Bolt M6×16	x	x	x	x	244	B8870-16	Hose Clamp 12-16	x	x	x	x
83	B5783-820	Bolt M8×20	x	x	x	x	245	QB673-12	Flexible Clamp	x	x	x	x
130	B6182-6	Locknut M6	x	x	x	x	246	5000140A	Fuel Line	x	x	x	x
145	B62-6	Nut M6	x	x	x	x	247	5000130	Adaptor	x	x	x	x
231	B1972-A12.5-1	Washer	x	x	x	x	248	5000144A	Fuel Line	x	x	x	x
232	5000605	Left Mask	x	x	x	x	249	3307041	Clamp	x	x	x	x
233	5000606	Right Mask	x	x	x	x	250	5000145A	Fuel Line (8.5×2)	x	x	x	x
234	5000654	Left Decoration	x	x	x	x	251	B818-616	Bolt M6×16	x	x	x	x
235	5000653	Right Decoration	x	x	x	x	252	4806020	Chock Cable	x	x	x	x
236	5000651	Control Panel ASM	x	x	x	x	253	523283B	Hour Meter	x	x	x	x
238	B5285-5.5×19	Bolt M5.5×19	x	x	x	x	254	2806005	Throttle Control ASM	x	x	x	x
239	5000657	Fuel Tank Pressing Strap	x	x	x	x	255	5208070	Ignition Switch ASM	x	x	x	x
240	2833024	Rold Weldment	x	x	x	x	256	5208022	Blade Control Sw itch	x	x	x	x
241	5000655	Fuel Tank	x	x	x	x	257	5000652	Control Panel	x	x	x	x

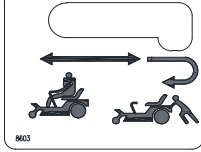
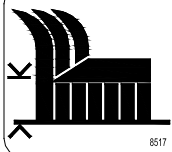
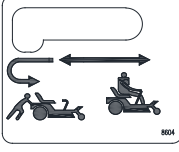

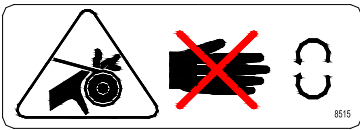
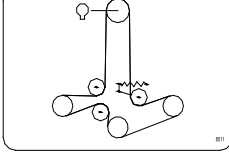
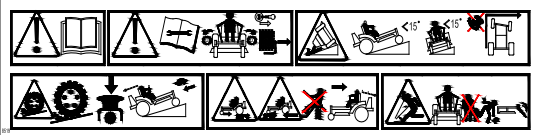
Tire Combination



Ref	P/N	Description	42XP	46XP	50XP	60XP	Ref	P/N	Description	42XP	46XP	50XP	60XP
7	GB6182-12	Locknut M16	x	x	x	x	269	B5782-12150	Bolt M12×150	x	x		
258	5002090B	Steering Wheel ASM	x	x			B5782-12180	Bolt M12×180			x	x	
	5002430C	Steering Wheel ASM			x	x	270	462110	Front Wheel (black)	x	x		
259	4200355	Drive Wheel 18×8.5-8	x				5002440A	Front Wheel (black)			x	x	
	5000050A	Drive Wheel 18×9.5-8		x			271	5002092	Caster Wheel Bushing	x	x		
	5000055	Drive Wheel 20×10-8			x	x	5002431	Caster Wheel Bushing			x	x	
260	5000001	Nut 1/2-20UNF	x	x	x	x	329	5002101	Tire 11×4	x	x		
261	B6184-16	Locknut M16	x	x	x	x	5002411	Tire 13×5			x	x	
262	B97.1-16	Flat Washer M16	x	x	x	x	330	B1153-6	Grease Fitting M6, 45°	x	x	x	x
263	B1972-A31.5	Washer	x	x	x	x	331	5002103	Bearing	x	x	x	x
264	B97.1-20	Flat Washer M20	x	x	x	x	332	463131	Wheel Rim 5×3	x	x		
265	B7915- AXK2035	Bearing AXK20×35	x	x	x	x	5002442A	Wheel Rim 6×3.2			x	x	
266	B290-HKH2020	Bearing HKH20×20	x	x	x	x	333	5000052A	Wheel Rim 8×7	x	x	x	x
267	B9877.1-28407	Grease Seal 28×40×7	x	x	x	x	334	5000051	Tire 18×9.5-8	x	x		
268	5002095A	Caster Wheel Yoke	x	x			5000056	Tire 20×10-8			x	x	
	5002435C	Caster Wheel Yoke			x	x							

 <p>276</p>	 <p>277</p>	<p>FUSE BLOCK 8509</p> <p>278</p>	 <p>279</p>	<p>MOTION CONTROL</p>  <p>280</p>	 <p>281</p>
 <p>282</p>	 <p>283</p>	 <p>284</p>	 <p>285</p>	 <p>286</p>	
 <p>287</p>	 <p>288</p>	<p>289</p>	<p>46</p> <p>290</p>		
 <p>291</p>		 <p>292</p>	<p>CAUTION</p> <p>DO NOT OPERATE WITHOUT GUARD IN PLACE</p> <p>293</p>		
<p>50</p> <p>294</p>	 <p>295</p>		<p>WARNING</p> <p>DO NOT OPERATE WITHOUT DISCHARGE DEFLECTOR, ENTIRE GRASS COLLECTION SYSTEM, OR MULCH KIT IN PLACE. DO NOT REMOVE GRASS CATCHER UNTIL BLADES HAVE STOPPED.</p> <p>296</p>		
<p>60</p> <p>297</p>	<p>WORLDLAWN POWER EQUIPMENT, INC MODEL NO: SERIAL NO: MADE IN CHINA</p> <p>298</p>	 <p>299</p>	<p>42</p> <p>300</p>		
<p>CAUTION</p> <ul style="list-style-type: none"> Loose or Damaged Blade Bolt may allow blade to come out from under deck at HIGH SPEED. Replace Blade Bolt after striking a foreign object. Torque Blade Bolt to 115-120 FT-LBS(158-163N m). <p>SEE OPERATOR'S MANUAL</p> <p>301</p>		<p>DANGER</p> <p>COVER IS MISSING. DO NOT OPERATE THIS UNIT WHEN COVER IS NOT IN PLACE.</p> <p>302</p>		<p>DANGER</p> <p>To avoid serious injury or death:</p> <ul style="list-style-type: none"> Avoid blades unless engine and blades are stopped.  <p>303</p>	
 <p>304</p>	 <p>305</p>	 <p>306</p>			

Safety/Operation and Product Decals



Ref	P/N	Description	42XP	46XP	50XP	60XP	Ref	P/N	Description	42XP	46XP	50XP	60XP
276	8502	Decal, Ignition	x	x	x	x	294	8513	Decal 50"			x	
277	8314	Decal	x	x	x	x	295	8519	Operational Warning	x	x	x	x
278	8509	Fuse Decal	x	x	x	x	296	8307	Discharge Warning	x	x	x	x
279	8507	Decal, Throttle	x	x	x	x	297	8327	Decal 60"				x
280	8512A	Motion Control	x	x	x	x	298		Serial Number Plate	x	x	x	x
281	8512B	Parking Decal	x	x	x	x	299	543383	WORLDLOGO-fuel tank	x	x	x	x
282	5000677	Worldlawn Decal	x	x	x	x	300	8381	Decal 42"	x			
283	5000678	Worldlawn Decal	x	x	x	x	301	8308	Shield Warning	x	x	x	x
284	8603	Transaxle Release LH	x	x	x	x	302	8305	Danger Foot Plate	x	x	x	x
285	8517	Cutting Height Locator	x	x	x	x	303	8325	Danger BladeS	x	x	x	x
286	8604	Transaxle Release RH	x	x	x	x	304	8550F	Viper Decal	x	x		
287	5000671	Snake Eye Decal	x	x	x	x	305	8550E	Viper XL Decal			x	x
288	5000672	Snake Eye Decal	x	x	x	x	306	5000655A	Worldlawn Decal	x	x	x	x
289	8501	International Logo	x	x	x	x	307	633387	Worldlawn Decal (803)				x
290	8606	Decal 46"		x			308	633388	Worldlawn Decal (803)				x
291	8515	Rotating Parts	x	x	x	x	309	633389	Worldlawn Decal (708)	x	x	x	
292	8511	Deck Belt Routing	x	x	x	x	310	633390	Worldlawn Decal (708)	x	x	x	
293	8303	Caution Guard	x	x	x	x							

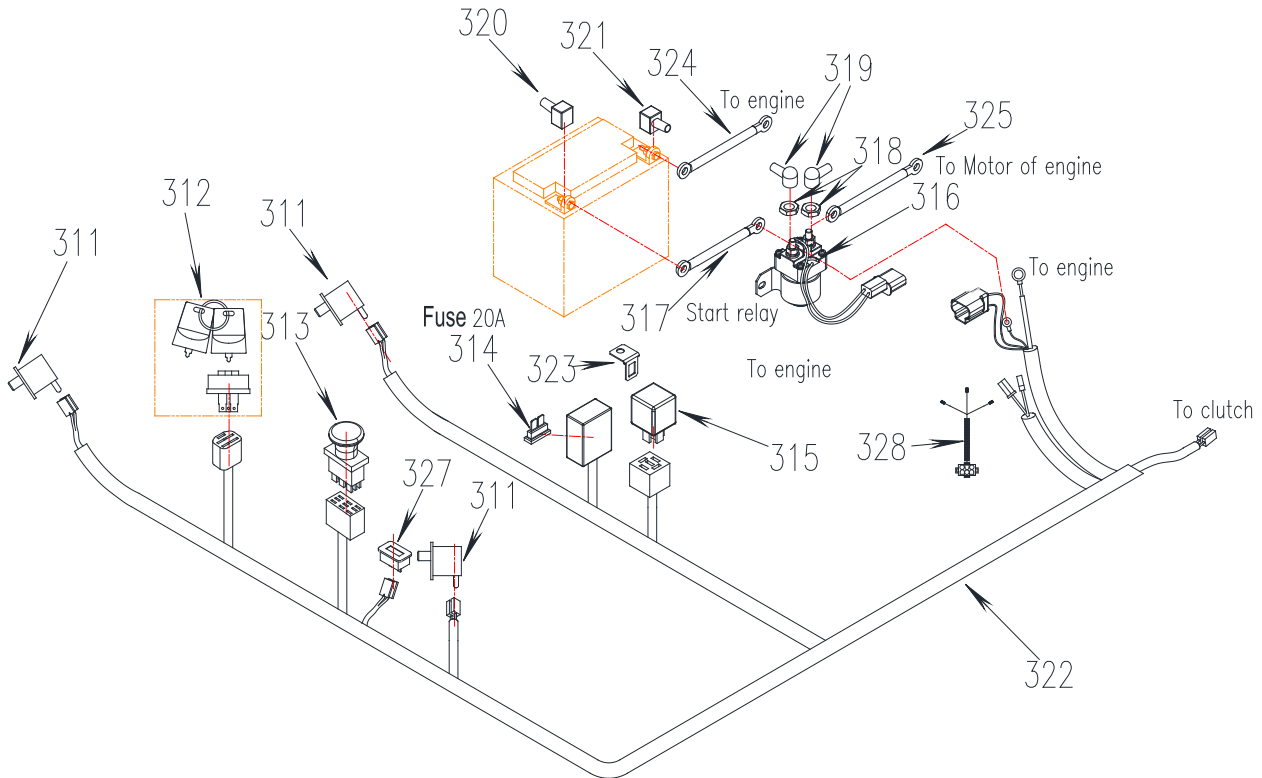

Ref	P/N	Description	42XP	46XP	50XP	60XP	Ref	P/N	Description	42XP	46XP	50XP	60XP
311	5008003	Plunger Switch	x	x	x	x	320	3312032	Battery Boot (Positive)	x	x	x	x
312	5208070	Ignition Switch ASM	x	x	x	x	321	3312031	Battery Boot (Negative)	x	x	x	x
313	5208022	Blade Control Switch	x	x	x	x	322	5008621B	Wiring Harness	x	x	x	x
314	5208007	Fuse 20A	x	x	x	x	323	5008012	Bracket of Relay	x	x	x	x
315	5008011	12V Relay	x	x	x	x	324	423118	Negative Cable	x	x	x	x
316	463234	Start-up Relay	x	x	x	x	325	3609004	Wire to Motor	x	x	x	x
317	423116	Positive Wire	x	x	x	x	327	523283B	Hour Meter	x	x	x	x
318	5008005	Nut 5/16-24UNF	x	x	x	x	328	5208033	Wiring Harness (Loncin)	x	x	x	x
319	2808107	Relay Cable Cover	x	x	x	x							



Worldlawn Power Equipment, Inc.

401 N. Commerce Street Beatrice NE 68310

Phone: (402) 228-4255 Fax: (402) 223-4103

www.worldlawn.com

Form No. 46103-202302